

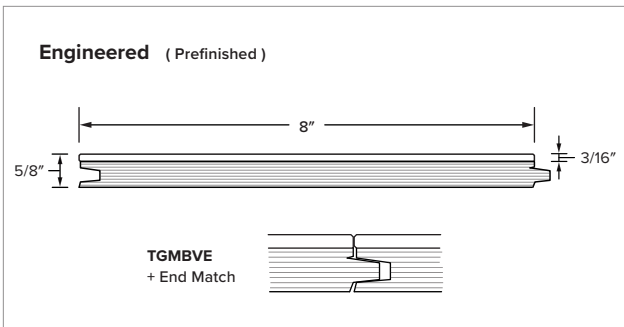

# The Natural Expressions Collection

## FLOORING DESIGNED WITH DAVID SENISE

Made with our sustainably harvested FSC® Certified Casual White Oak, the Natural Expressions Collection utilizes an 8" wide plank format and an all-natural UV Cured Hard-Wax oil finish, giving any space an organic flow by allowing each board to express a variety of wood grain patterns. Developed in collaboration with celebrated interior designer David Senise, this collection combines elements inspired by nature to bring thoughtful sophistication & grounded aesthetics from the natural world into commercial & residential spaces.



### CUT AND PASTE SPECIFICATION INTO APPROPRIATE CSI DIVISION

- 09 64 30 — Engineered Wood Flooring
- 09 64 29—Wood Strip and Plank Flooring
- 06 42 00—Wood Paneling

### MANUFACTURER

Pioneer Millworks  
1180 Commercial Dr  
Farmington, NY 14425

### MATERIALS

**Product:** Natural Expressions Collection: Casual White Oak  
**Collection:** The Natural Expressions Collection  
**Species:** Natural Expressions Collection  
**Core:** 9-Ply FSC® Certified & TCSA Compliant Birch Plywood  
**Texture:** Smooth Planed  
**Source:** Sustainably Harvested Forests  
**Color:** Available in a range of finishes by inspired by Nature.  
**Finish:** UV Cured Hard-Wax Oil  
**Hardness:** 1360  
*(Janka Ball Test ASTM D1037-96A, Natural wood products have no minimum hardness since hardness is a characteristic of species and cannot be controlled)*

### DIMENSIONS & MILLING

#### Engineered ( Prefinished )

<b>Thickness:</b>	<b>5/8"</b>	<b>Profile:</b>	<b>T&amp;GMBVE</b> (Tongue and Groove Micro Bevel Edge)
<b>Width:</b>	<b>8"</b>	<b>Core:</b>	<b>1/2"</b>
<b>Length:</b>	<b>18" – 12'</b> random	<b>Wear Layer:</b>	<b>3/16"</b>

### ADDITIONAL INFORMATION

**Heartwood:** 75% or greater Heartwood  
**Grain:** No restriction on grain orientation  
**Knots:** No restriction on sound knots  
**Voids:** In engineered prefinished product voids up to 1" in diameter will be filled with a black composite.  
*Insect marks, including pinholes, may also be present on the surface.*

**Discoloration:** Limited mineral staining is permitted.  
**Checks:** Only minor surface checking is permitted.  
**Moisture Content:** Kiln dried 6–9% prior to milling.

### CERTIFICATIONS & LEED INFORMATION

**FSC® Claim:** FSC® Mix (SCS-COC-003998-D)  
**Greenguard GOLD Certified**  
**MRC5:** Regional Materials (call for details)

### INSTALLATION RECOMMENDATIONS

**Overage:** Minimum 10% additional material  
*for on-site grading, trimming and installation factors.*

**Climate:** As with any wood flooring product, the room temperature should be held at a consistent range between **60-80° F** with relative humidity between **30-60%**.  
*Environmental conditions consistently outside of these parameters could result in product performance issues.*





**Shoji White**

SKU# 27162114911

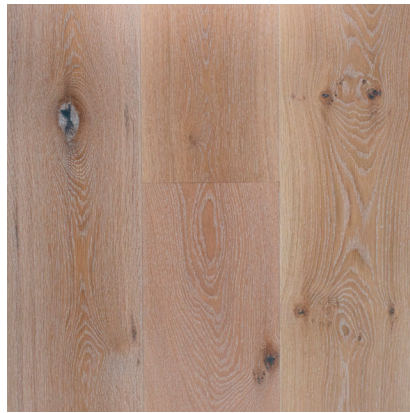

**Hazelwood**

SKU# 27162115011

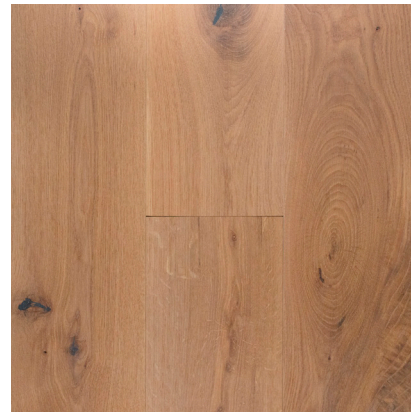

**Ginger Root**

SKU# 27162115111

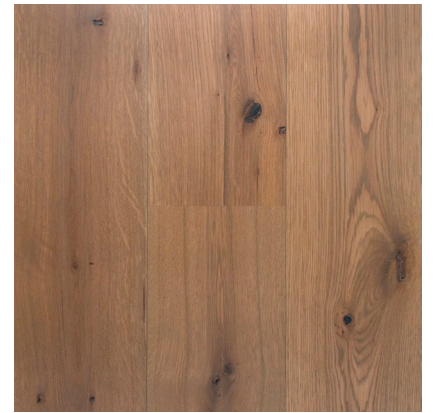

**Toasted Wheat**

SKU# 27162115211

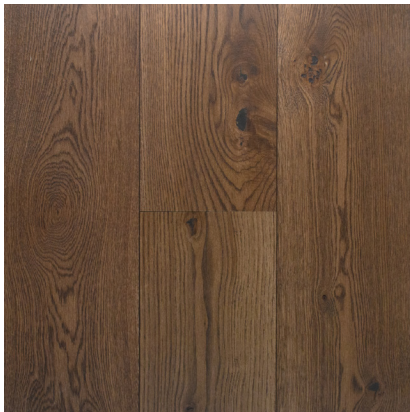

**Autumn Brown**

SKU# 27162115311

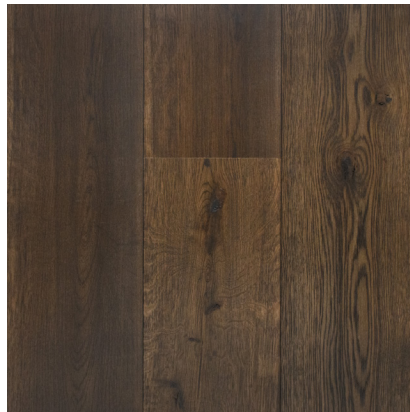

**Coffee Bean**

SKU# 27162115411

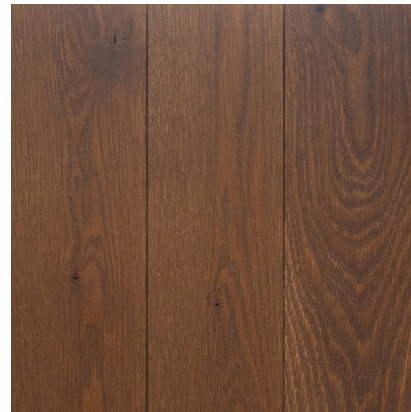

**Warm Umber**

SKU# 27162115511

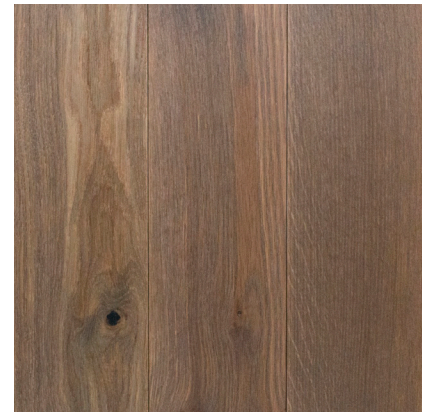

**Royal Acorn**

SKU# 27162115611

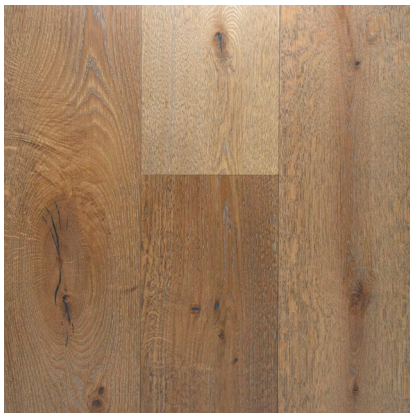

**Driftwood**

SKU# 27162115711

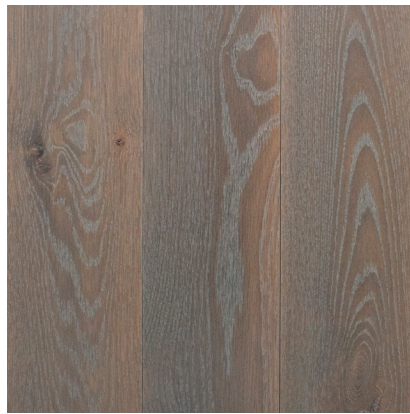

**Nantucket Fog**

SKU# 27162115811



**Rain Cloud**

SKU# 27162115911



**Osaka Black**

SKU# 27162116011